

HF2021

AVE
LIGHTING

Fixture Style

Thank you for your purchase. Welcome to the Avenue Lighting Family. Please follow these instructions carefully as they contain important information about the safety, use and disposal of this product. Read and understand all instructions before proceeding with assembly and installation of this fixture.

- This fixture **MUST** be installed by a licensed electrician.
- Read & understand the entire installation sheet.
- DO NOT substitute any parts, leave parts out, or use parts that are worn out or broken.
- Suitable for the use of 110-130V and 60Hz
- Please wear gloves during installation to avoid damage to the plating.
- Must be installed in a fixed location and be checked yearly.
- Please turn off the light source with a soft cloth as cleaning with a detergent is prohibited.

Preparation:

Carefully remove the fixture from the carton and check that all parts are included as shown in the illustration. If any parts are missing or damaged, DO NOT attempt to assemble the product.

Tools Required (not included):
Phillips screwdriver
Flathead screwdriver
Wire Strippers
Electrical Tape
Ladder
Safety Glasses + Gloves

Parts:

- 1.Bracket Mounting
- 2.Bracket Mounting Screws
- 3.lamp body
- 4.crystal

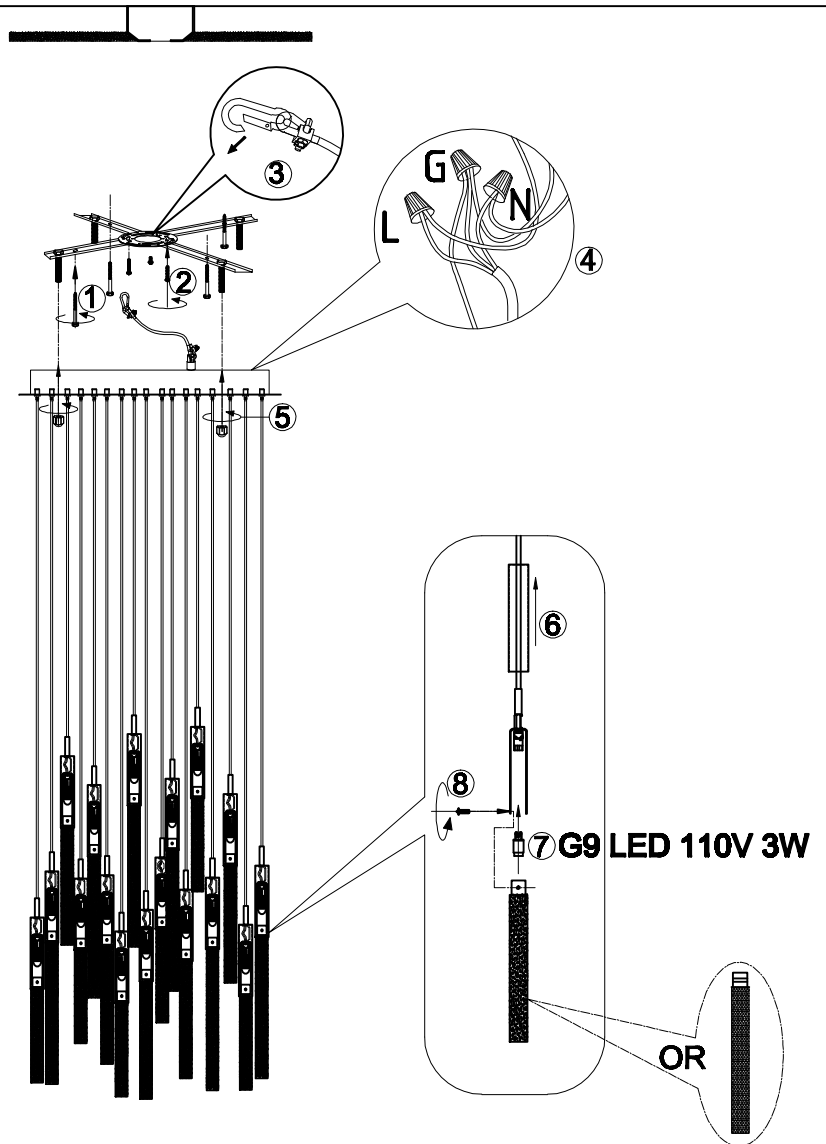

Clean with a soft damp cloth.
www.AvenueLighting.com

